

For reference only. See data sheet for the detailed specifications.

## Technical Specification



Frequency Range(GHz)	170.0 – 260.0
Waveguide	WR4
Gain(dBi)	25 Typ.
Polarization	Linear
3dB Beamwidth(deg)	E Plane: 8 Typ.
	H Plane: 9 Typ.
Cross Pol. Isolation(dB)	35 Typ.
VSWR	1.25:1 Max.
Output	UG-387/U-M
Material	Cu
Finish	Gold Plated
Size(mm)	19.05 x 19.05 x 62.2
Net Weight(Kg)	0.05 Around

## Outline Drawing (Size: mm)

UG-387/U-M Output (P/N: LB-CNH-4-25-A)

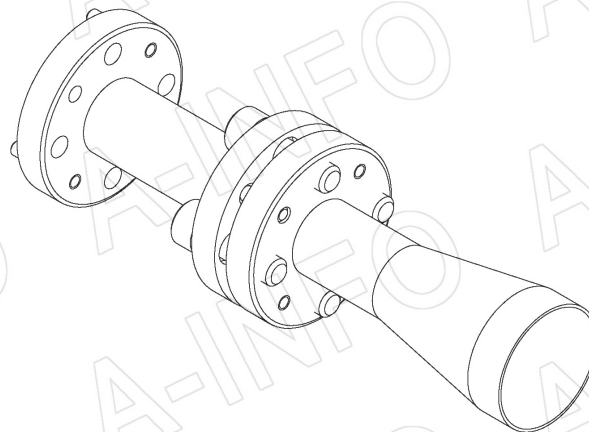
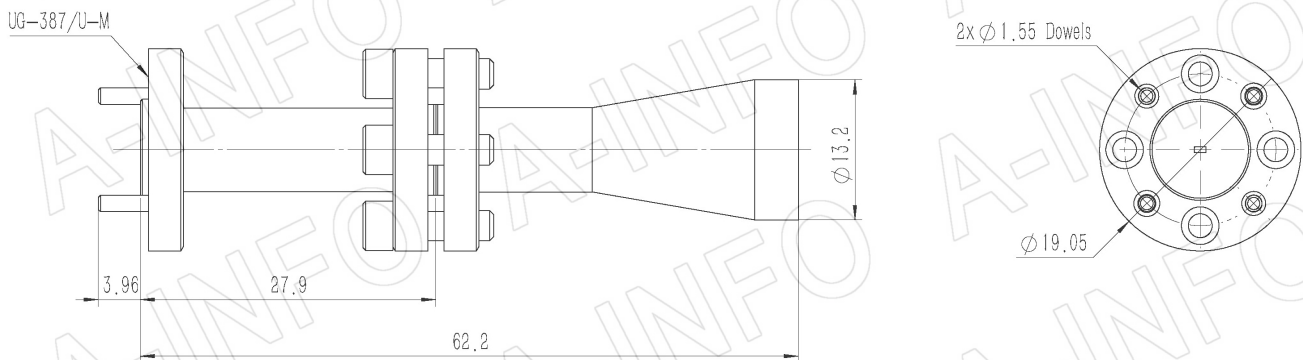

## Flange Drawing (Size: mm)

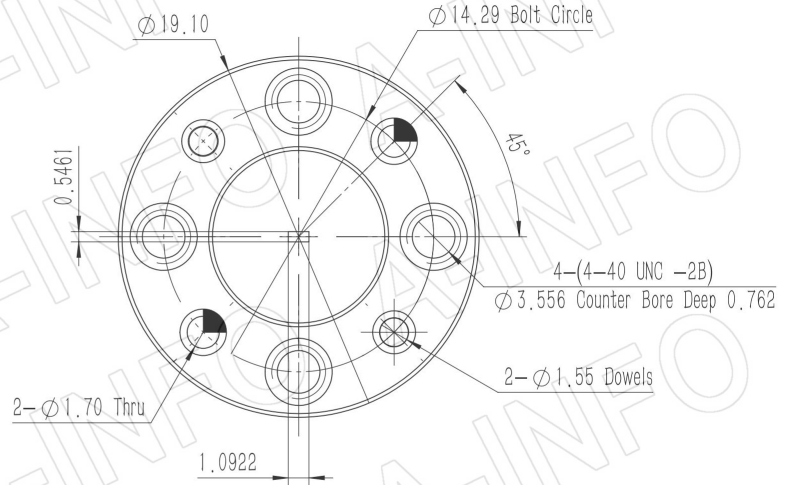
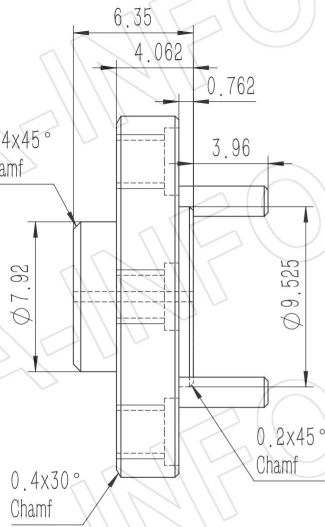

UG-387/U-M

## Test Results

### 1. Gain & Antenna Factor

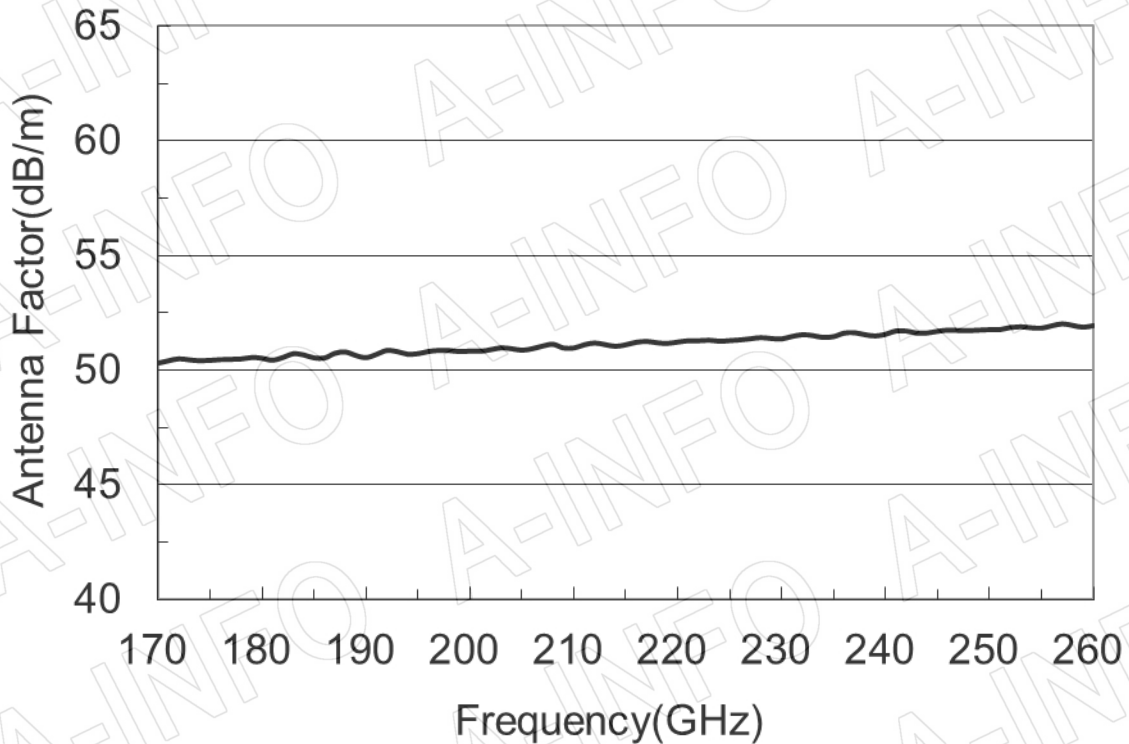
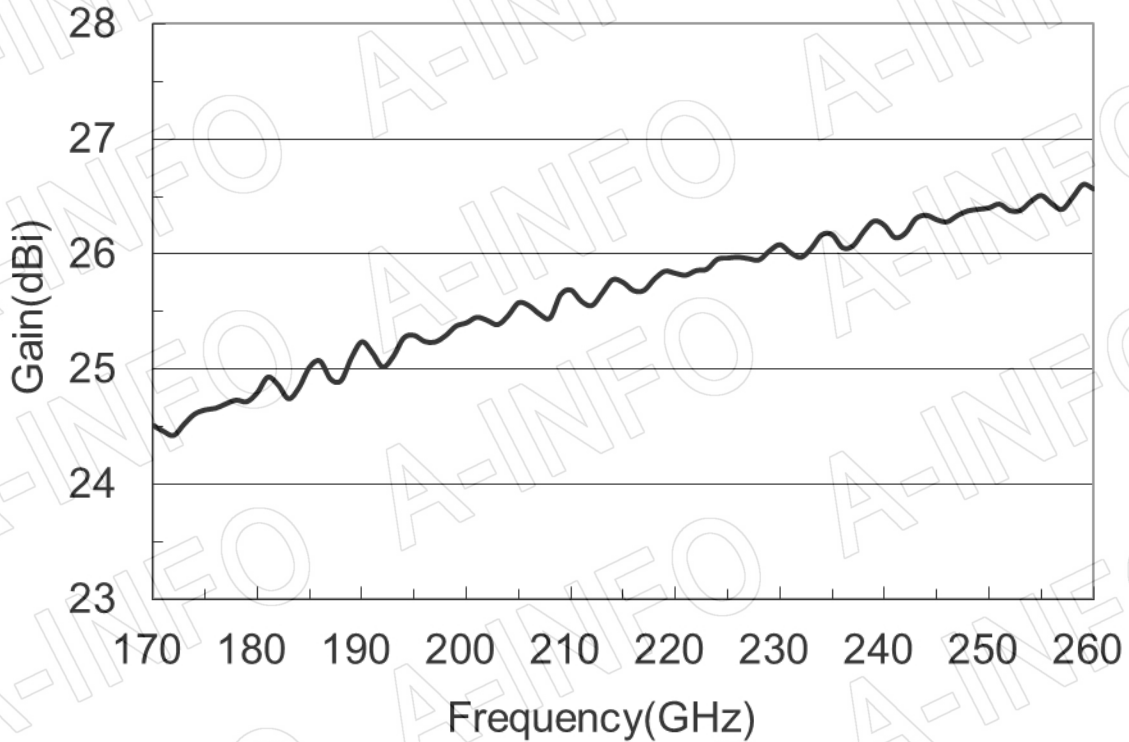

## 2. Pattern

